

New methods of uranium (IV) production using a Pt-loaded gas-diffusion electrode

M. SHIBATA, N. FURUYA

Department of Applied Chemistry, Faculty of Engineering, Yamanashi University, Takeda-4, Kōfu, Japan

Received 2 January 1990; revised 29 May 1990

Normal uranium(IV) production is carried out by conventional electrolysis in a commercial plant. Here we propose new methods, the local-cell mode and the fuel-cell mode, for the production of uranous nitrate using a platinum-loaded gas-diffusion electrode. It is shown that uranyl ions are spontaneously reduced to 250–300 g dm⁻³ U(IV) using these methods and that electrical energy is obtained by the fuel-cell mode.

1. Introduction

Hydrazine-nitrate-stabilized aqueous uranous nitrate solutions are produced for use as plutonium reductant in a “Purex” type aqueous reprocessing plant [1]. The uranous nitrate solutions are obtained by electro-reduction of uranyl nitrate solutions [1, 2]. Uranyl ions are reduced to uranous ions at the cathode, and oxygen gas is evolved at the anode. These reactions are as follows:

cathode reaction

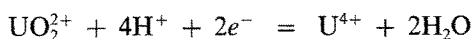

anode reaction

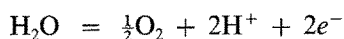

overall reaction



During electrolysis, the anode (platinized titanium) and the cathode (titanium) are separated by a cation-exchange membrane so that the uranous ions produced at the cathode are not re-oxidized at the anode [2].

When the anode reaction is replaced by another reaction, which takes place at a potential lower than the reduction potential (0.33 V with respect to SHE) [3] of the uranyl ion, it is not necessary that electrical energy is supplied to the system, because the uranyl ions can be spontaneously reduced to uranous ions in a cell reaction. For instance, the cell having an e.m.f. of 0.33 V, is formed by a reduction of uranyl ions at the cathode in combination with hydrogen oxidation at the anode when the anode reaction is replaced by hydrogen oxidation ($E_0 = 0 \text{ V}$). The reactions are as follows:

cathode reaction

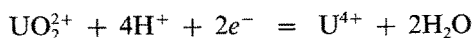

anode reaction

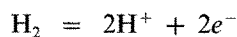

overall reaction

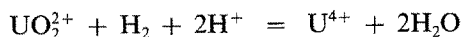

In this paper, we propose two methods, the local-cell mode and the fuel-cell mode, as described in Section 2, for the production of uranous ions. The objective of this work is to demonstrate experimentally the production of uranous ions using the new methods with the uranyl/uranous/nitric acid system as an example, and to compare the local-cell and fuel-cell mode using a gas-diffusion electrode to a conventional electrochemical cell arrangement.

2. Principle

2.1. Local-cell mode

Provided that the cathodic and anodic reactions take place at neighbouring regions on an electrode, i.e. a local cell is formed, the reduction of uranyl ions and hydrogen oxidation take place spontaneously.

The principle is shown in detail in Fig. 1. A platinum wire is immersed in an electrolyte with uranyl ions. A gas/liquid/solid interface which consists of hydrogen gas, uranyl nitrate solution and a platinum electrode is formed at the meniscus. Hydrogen gas is oxidized and forms hydrogen ions as well as electrons at part of the interface. The uranyl and hydrogen ions react with electrons and form uranous ions and water.

The extent of the gas/liquid/solid interface where

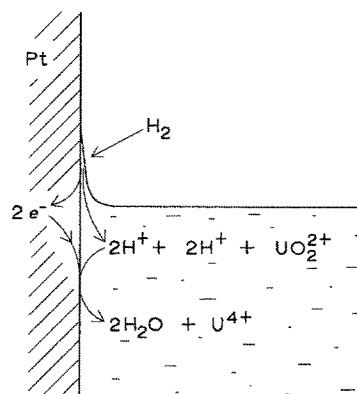

Fig. 1. Reduction mechanism of uranyl ion in a local cell.

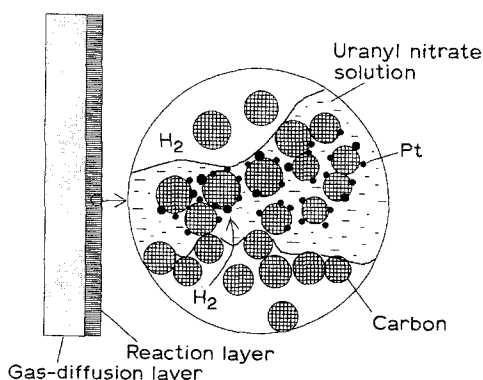

Fig. 2. Cross-section of a gas-diffusion electrode model.

hydrogen gas is oxidized has to be increased to a greater extent on the electrode in order to reduce the uranyl ions to uranous ions at the practical rate required in a commercial plant. The platinum loaded gas-diffusion electrode used in hydrogen-oxygen fuel cells has such a large gas/liquid/solid interface that hydrogen gas is easily oxidized on the electrode [4-6]. Thus, provided the uranyl ions and hydrogen gas are supplied to a reaction layer of the gas-diffusion electrode and to its gas-diffusion layer, respectively, local cells can be formed in the reaction layer shown in Fig. 2, that is, the cell reaction takes place at the platinum catalyst.

2.2. Fuel-cell mode

Although the e.m.f. of this reaction is 0.33 V, electrical energy using the local-cell mode described above cannot be obtained. Provided that the cathode reaction is separated from the anode reaction and that the cathode and anode are connected externally, i.e. the reactions take place in a fuel cell, uranous ions are spontaneously produced, moreover electrical energy can be obtained. A gas-diffusion electrode having a large gas/liquid/solid interface is required for the anode so that hydrogen gas is easily oxidized at the electrode. The reduction of U(VI) can take place at a platinum gauze cathode in the catholyte.

3. Experimental details

3.1. Pt-loaded gas-diffusion electrode

The gas-diffusion electrode consists of a reaction layer and a gas-diffusion layer. The hydrophilic portion, which is an electrolyte supplying channel, and the hydrophobic portion, which is a hydrogen gas supplying channel, are fully blended in the reaction layer in order to form the gas/liquid/solid interface effectively [4-6].

The reaction layer consists of the hydrophilic portion and the hydrophobic portion. The hydrophilic portion was made of powder X (AB12:PTFE = 72.5:27.5) which blends a hydrophilic carbon black (AB12, Denki-Kagaku Kogyo) and polytetrafluoroethylene (PTFE, D-1, Daikin Kogyo). The hydro-

phobic portion was made of the powder Y (Denka Black:PTFE = 6.5:3.5). The reaction layer was made of powder X and powder Y (X:Y = 7:3).

The gas diffusion layer, which was made of the powder Y, consists of many hydrophobic micropores and has the dual function of supplying hydrogen gas to the reaction layer and of preventing infiltration of the electrolyte, which oozes out of the gas-diffusion layer at lower than 200 N cm^{-2} of water pressure.

The powder for the reaction layer and the gas diffusion layer was pressed at a condition of 380°C and 6000 N cm^{-2} , and the gas-diffusion electrode for the local-cell mode was obtained. For the fuel-cell mode, the powder for the reaction layer, the powder for the gas diffusion layer and the copper mesh for electrical contact were pressed at a condition of 380°C and 6000 N cm^{-2} . A platinum catalyst (0.56 mg cm^{-2}) was loaded on the reaction layer.

3.2. Reactor and solutions

3.2.1. Local-cell mode. Figure 3 shows a cross-sectional view of the local-cell type reactor which was made of methacrylic acid ester resins. The surface area of the reaction layer of the gas-diffusion electrode was 12.5 cm^2 . The electrolyte (15 ml), which consisted of 350 g dm^{-3} U(VI), i.e. 1.47 M uranyl nitrate, 3 M nitric acid, water and 0.35 M hydrazine as a stabilizer [1], or of 90 g dm^{-3} U(VI), i.e. 0.375 M uranyl nitrate and 1.42 M nitric acid, was stirred by a magnetic stirrer.

3.2.2. Fuel-cell mode. Figure 4 shows a cross-sectional view of the fuel-cell type reactor which was made of methacrylic acid ester resins. The surface area of the reaction layer of the gas-diffusion electrode as an anode was 12.5 cm^2 . A ring-shaped platinum gauze (50 mesh, 40 cm^2) cathode was placed above the gas-diffusion electrode.

The anode and cathode were connected through an external resistance (0.2Ω).

The catholyte (15 ml), which consisted of 350 g dm^{-3} U(VI), i.e. 1.47 M uranyl nitrate, 3 M nitric acid, water and 0.35 M hydrazine as a stabilizer [1] was stirred using a magnetic stirrer. A 2 M H_2SO_4 solution was used as the anolyte, because the performance of a

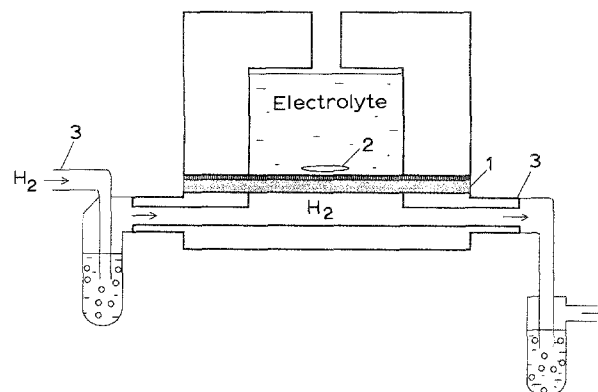

Fig. 3. Schematic illustration of local-cell type reactor. (1) gas-diffusion electrode, (2) magnetic stirrer, (3) bubbler.

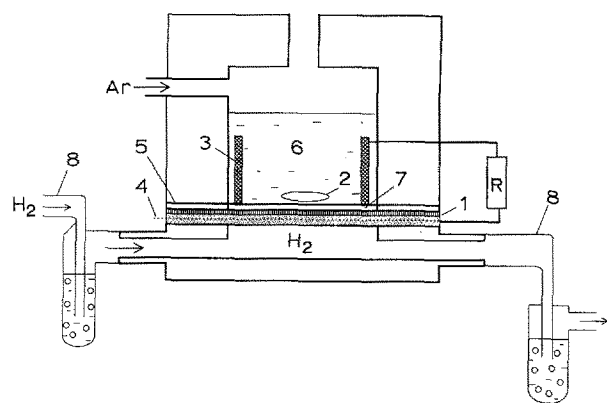

Fig. 4. Schematic illustration of fuel-cell type reactor. (1) gas-diffusion electrode, (2) magnetic stirrer, (3) Pt gauze electrode, (4) Cu mesh, (5) Nafion 117, (6) catholyte (7) anolyte, (8) bubbler.

gas-diffusion electrode in a nitric acid solution is inferior to that in a sulphuric acid solution [7]. Therefore, the anolyte and catholyte were separated by a cation-exchange membrane (Nafion 117, Du Pont).

3.3. Measurement

The time dependence of the concentration of uranyl and uranous ions was measured after supplying hydrogen gas. The experiments were carried out at 25°C in a clean room.

Analysis of the uranyl and uranous ions was carried out using a spectrophotometer (U-2000, Hitachi) at 416 nm and 627 nm, respectively.

4. Results and discussion

4.1. Local-cell mode

After hydrogen gas was supplied to the reactor the electrolyte started to change colour, the uranyl ions being reduced to uranous ions. Figures 5a and b show typical relations between wavelength and absorbance

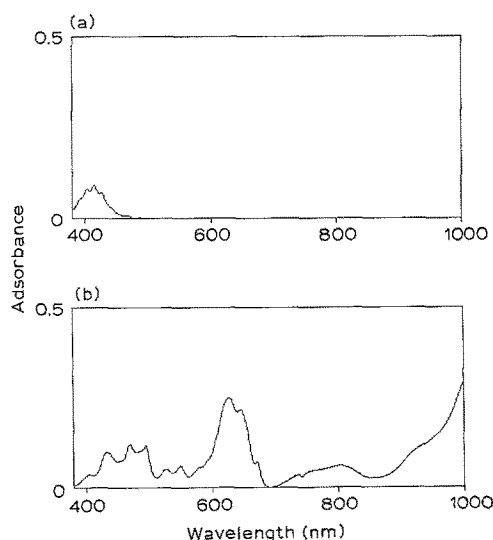

Fig. 5. Typical relation between wavelength and absorbance. (a) electrolyte containing 350 g dm⁻³ U(VI), 3 M nitric acid, water and 0.35 M hydrazine. (b) product after the reduction of uranyl nitrate solution.

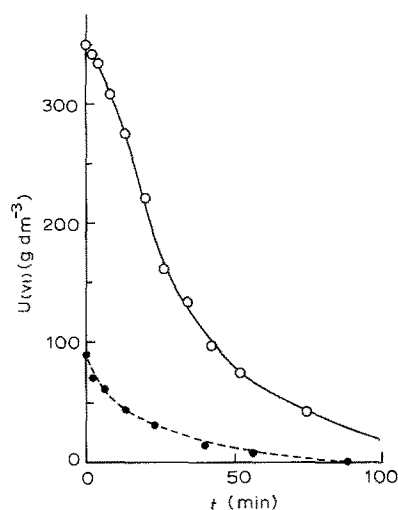

Fig. 6. Time dependence of the concentration of uranyl nitrate in local cell mode. Solid line: uranyl nitrate solution containing 350 g dm⁻³ uranium(VI), 3 M nitric acid, water and 0.35 M hydrazine. Dotted line: uranyl nitrate solution containing 90 g dm⁻³ U(VI) and 1.42 M nitric acid.

at the electrolyte, which consisted of 350 g dm⁻³ U(VI), nitric acid, water and hydrazine, and at the electrolyte after the reduction of uranyl nitrate, respectively. The decrease of uranyl ions was identical with the increase of uranous ions.

Figure 6 shows the time dependence of the concentration of uranyl nitrate. The concentration of uranyl ions in the electrolyte decreases to half the initial concentration of 90 g cm⁻³ U(VI) after 16 min, and to one-quarter after 32 min, as shown by the dotted line [8]. The potential of the gas-diffusion electrode was approximately 5 mV/NHE. The concentration of uranyl ions in the electrolyte decreases to one-half of the initial concentration of 350 g dm⁻³ U(VI) after 25 min, and to one-quarter after 45 min, as shown by solid line. The high concentration of more than 300 g dm⁻³ U(IV) was easily obtained by the local-cell mode after 75 min. The initial potential of the gas-diffusion electrode was approximately 250 mV/NHE. The potential lowered with decreasing the concentration of uranyl nitrate, and then became about 5 mV/NHE.

Figure 7 shows the relation between the logarithm of the concentration of uranium(VI) and time. The reduction of uranyl ions in the electrolyte containing the initial concentration of 90 g dm⁻³ U(VI) is shown to be first order, as shown by the dotted line [8]. Thus it is considered that the rate-determining step of the reduction is the diffusion of uranyl ions in the electrolyte to the reaction layer.

The reduction of uranyl ions in the electrolyte containing the initial concentration of 350 g dm⁻³ U(VI) is not a first order reaction in the initial stages, as shown by the solid line. The initial potential of the gas-diffusion electrode was about 250 mV/NHE, as mentioned above. However the plots were linear after 25 min, and the gas-diffusion electrode potential became lower than 50 mV/NHE. Thus, it is probable that the diffusion of uranyl ions determines the reduction rate at concentrations lower than

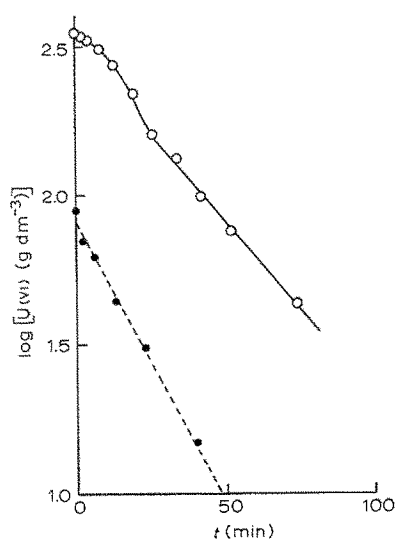

Fig. 7. Relation between logarithm of the concentration of U(VI) and time in local cell mode. Solid line: uranyl nitrate solution containing 350 g dm^{-3} uranium(VI), 3 M nitric acid, water and 0.35 M hydrazine. Dotted line: uranyl nitrate solution containing 90 g dm^{-3} U(VI) and 1.42 M nitric acid.

approximately 175 g dm^{-3} U(VI). In addition, the rate shown by the dotted line in Fig. 7 is greater than that shown by the solid line. This difference is caused by the influence of the concentration of nitric acid, that is, the high concentration of nitrate ions deactivate the platinum catalyst in the reaction layer of the gas-diffusion electrode [7].

The production rate of uranous nitrate at the local-cell mode in the electrolyte containing the initial concentration of 350 g dm^{-3} U(VI) was estimated in terms of current density. The mean current density for up to 50% conversion in the local-cell mode is 114 mA cm^{-2} . This value is lower than the current density of 216 mA cm^{-2} in the commercial plant [1]. Nevertheless, the local-cell mode using a gas-diffusion electrode has some advantages. For instance, 170 g dm^{-3} U(IV) is produced from the catholyte containing 350 g dm^{-3} U(VI) in the conventional electrolytic reduction [1]. On the other hand, in the case of the local-cell mode, the high concentration of more than 300 g cm^{-3} U(IV) can be easily obtained.

4.2. Fuel-cell mode

The catholyte consisted of 3 M nitric acid solution with 0.35 M hydrazine and 350 g dm^{-3} U(VI). When hydrogen gas was supplied to the gas-diffusion layer, the e.m.f. of the cell made up of the gas-diffusion electrode and the platinum gauze electrode was found to be 438 mV.

When the anode and cathode were connected externally, current was observed, and the catholyte started to change colour, uranyl ions being reduced to uranous ions. Figure 8 shows the time dependence of the concentration of uranyl nitrate. The concentration of uranyl ions decreased in proportion to reaction time for the first 70 min, and to one-half of the initial concentration subsequently.

Figure 9 shows the time dependence of the cell

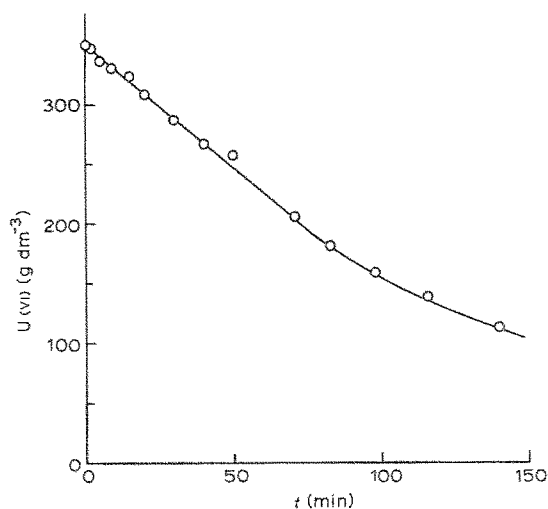

Fig. 8. Time dependence of the concentration of uranyl nitrate in fuel cell mode.

voltage when the anode and cathode were connected through an external resistance of 0.2Ω . The cell voltage was 111 mV immediately after the start of the reaction, increased slightly in the initial stages, and then decreased with decreasing concentration of uranyl ions. Thus it was shown that electrical energy can be obtained by the fuel-cell mode, although the cell voltage is low.

The cell voltage decreased strikingly after 70 min. When the reaction was stopped after 150 min, a large hydrogen bubble was found between the anode and the cation-exchange membrane in the electrolyte. Thus the area of reaction layer in contact with the electrolyte had decreased to approximately half, and the internal resistance between the anode and the cathode increased. Nevertheless it is expected that the striking decrease of cell voltage can be prevented by making the cell arrangement perpendicular and circulating the electrolyte.

Figure 10 shows the time dependence of the total quantity of electricity for the reduction and of the amount of uranous ions formed. The amount of uranous ions formed increased with increasing reaction time. It was observed that 250 g dm^{-3} U(IV) was spontaneously produced using the fuel-cell mode for 150 min.

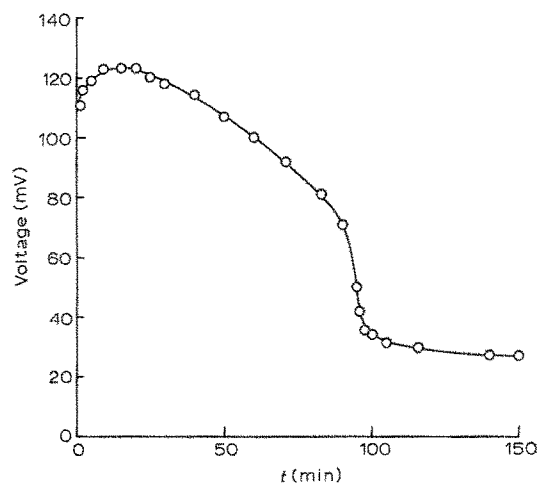

Fig. 9. Time dependence of cell voltage in fuel cell mode.

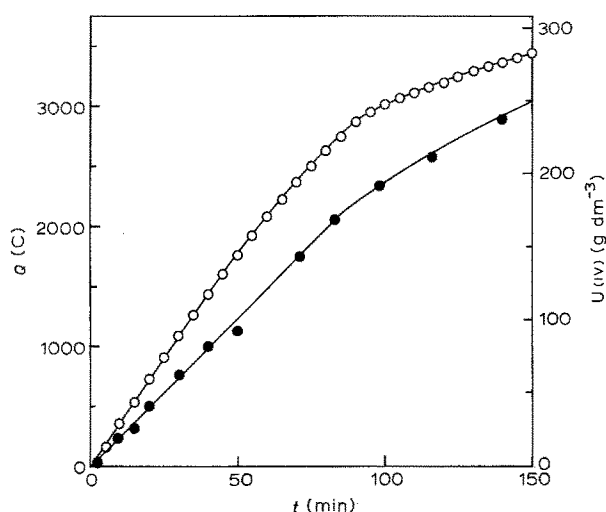

Fig. 10. Time dependence of the total quantity of electricity for reduction of uranyl ions and of the amount of uranous ions formed in fuel cell mode. (●) The amount of uranous ions measured, (○) the integral value of currents measured.

The total quantity of electricity obtained by integration of currents was 3450 C for 150 min, as shown by the open circles in Fig. 10. If the quantity of electricity for 150 min is calculated in terms of the amount of uranous nitrate formed, the value was 3000 C, as shown by the closed circles in this figure. The quantity of electricity obtained by current measurement is larger than that calculated by the amount of uranous nitrate produced. It is considered that some oxygen reduction also takes place on the cathode in spite of substituting argon gas for air in this experiment.

5. Conclusions

1. The high concentration of more than $250\text{--}300\text{ g dm}^{-3}$ U(IV) can be easily obtained using the local cell mode and the fuel-cell mode.
2. In the case of the local-cell mode, the cell consists simply of a gas-diffusion electrode and a system of circulation for uranyl nitrate solution and hydrogen gas, although hydrogen gas is required instead of the power source. Provided that hydrogen gas can easily be obtained reduction using hydrogen gas will be the more economical method.
3. In the fuel-cell mode, uranous ions are produced; furthermore electrical energy can be obtained.

References

- [1] E. Lopez-Menchero, L. Gehem, H. Eschrich, P. Hansen, J. Centeno and R. Aerts, ETR-180 (1966) EURO-CHEMIC Mol (Belgium).
- [2] See, for instance: 'Denki Kagaku Binran' (4th edition), The Electrochemical Society of Japan (ed.), Maruzen, Tokyo (1985) p. 299.
- [3] C. Robert (ed.), 'CRC Handbook of Chemistry and Physics', 68th ed., CRC Press, Boca Raton (1987) p. D-154.
- [4] S. Motoo, M. Watanabe and N. Furuya, *J. Electroanal. Chem.* **160** (1984) 351.
- [5] S. Motoo, R. Hirasawa, K. Ota and N. Furuya, Research Projects in Review 1987, Nissan Science Foundation, Tokyo **10** (1987) 191.
- [6] N. Furuya and E. Tonegawa, 55th Annual Meeting of Electrochem. Soc. Japan, Abstracts, The Electrochemical Society of Japan, Tokyo (1988) A107.
- [7] N. Furuya and M. Shibata, *Denki Kagaku* **58** (1990) 848.
- [8] *Idem*, *J. Electroanal. Chem.* **267** (1989) 321.